

SAMSARA

Medium Wheeled Utility Vehicle

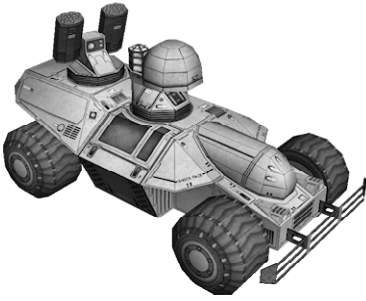

www.toposolitario.com



SAMSARA

MEDIUM WHEELED UTILITY VEHICLE

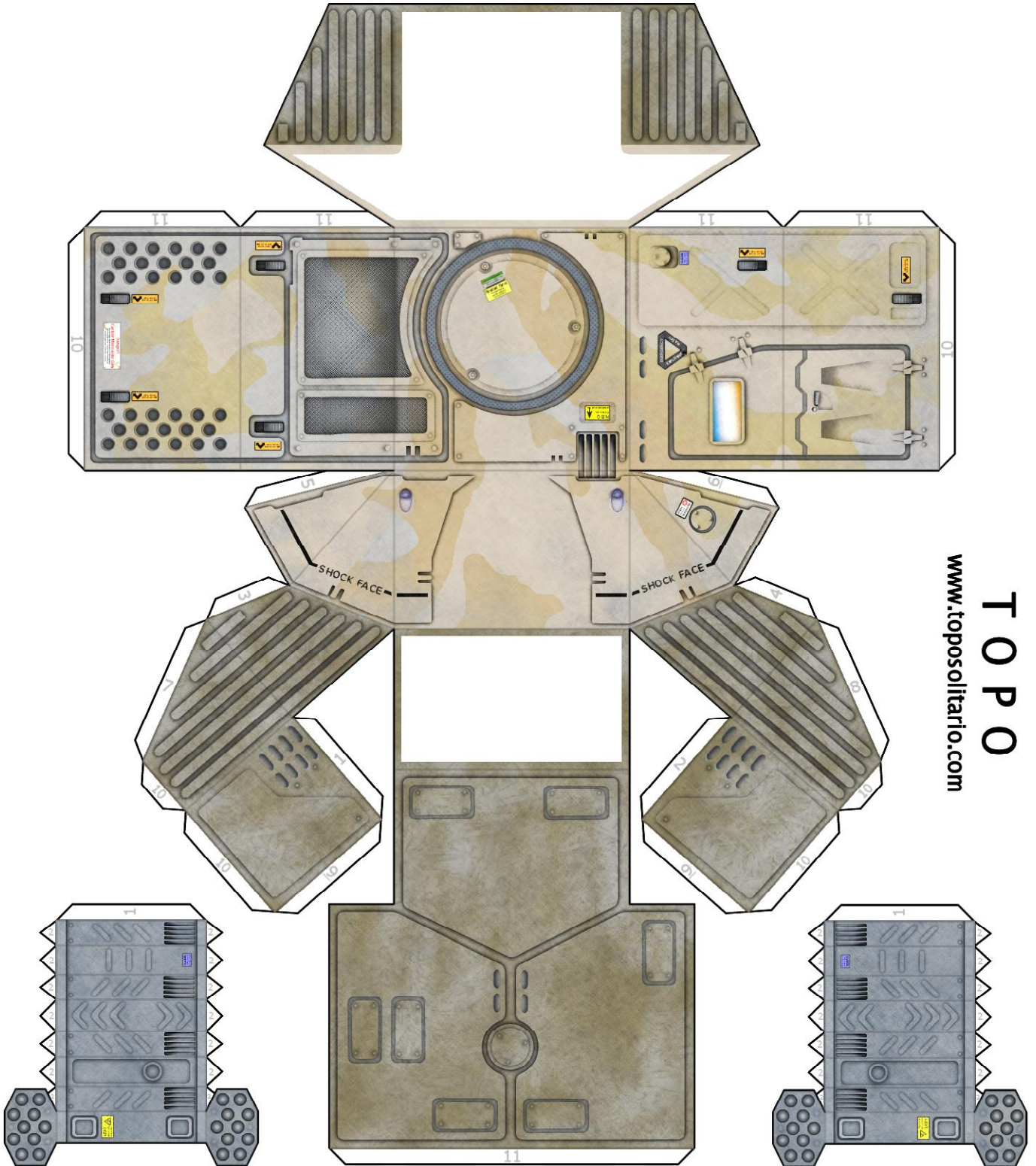

TOP O
www.toposolitario.com

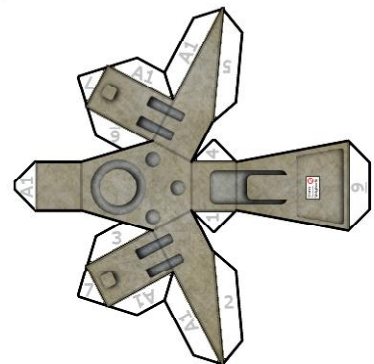
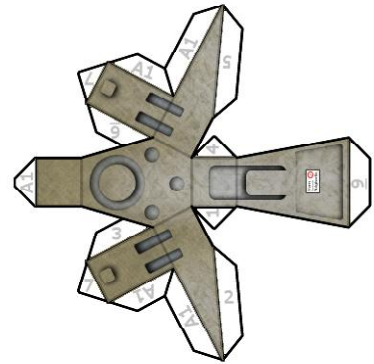
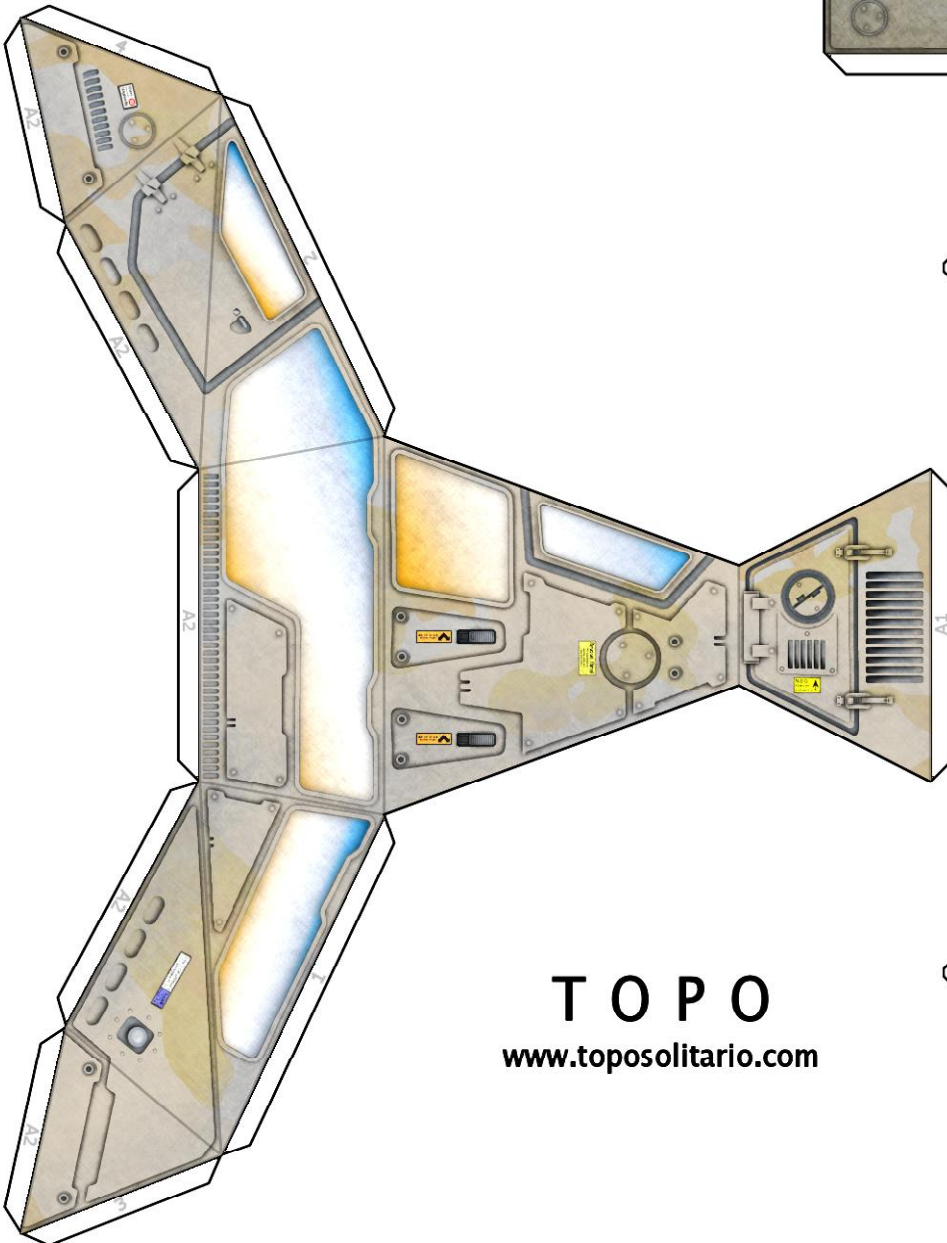
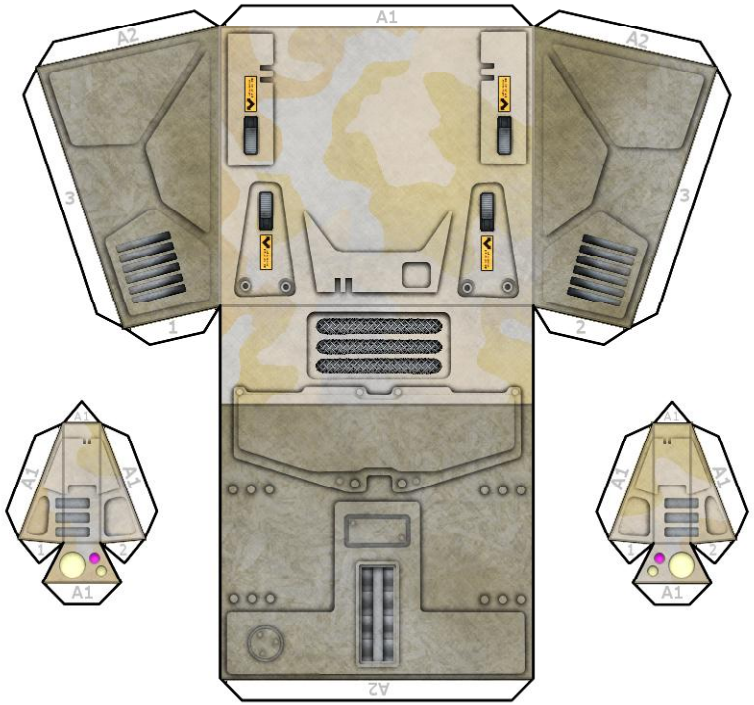
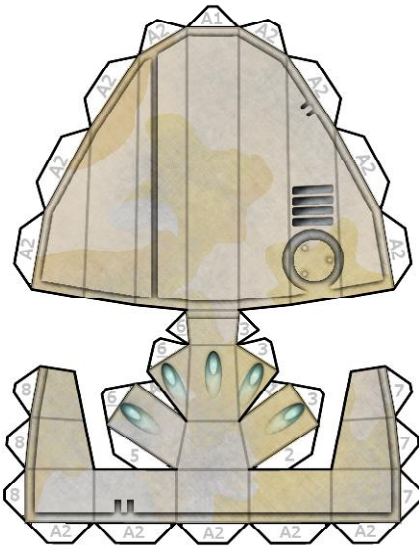

TOPO
www.toposolitario.com

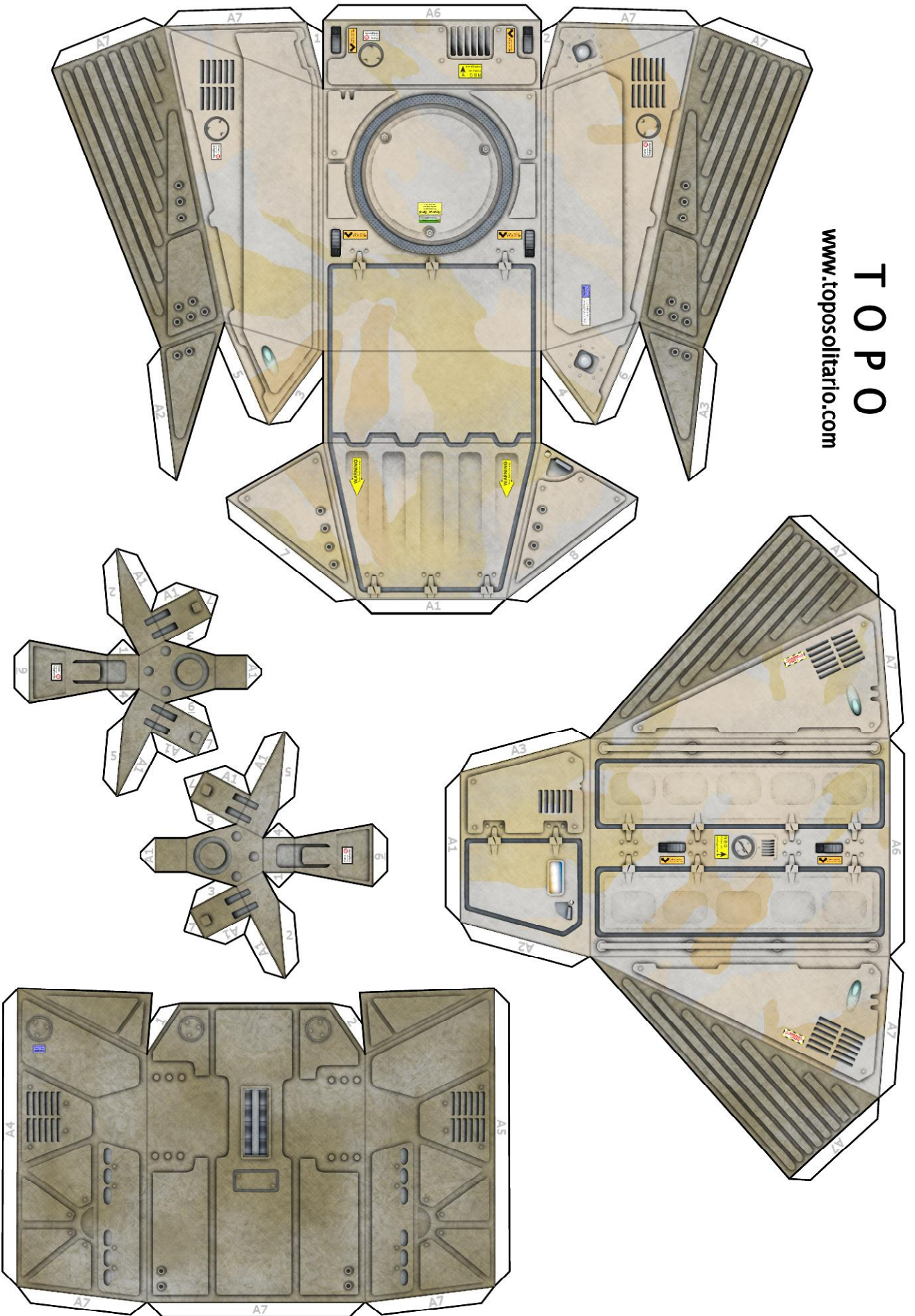

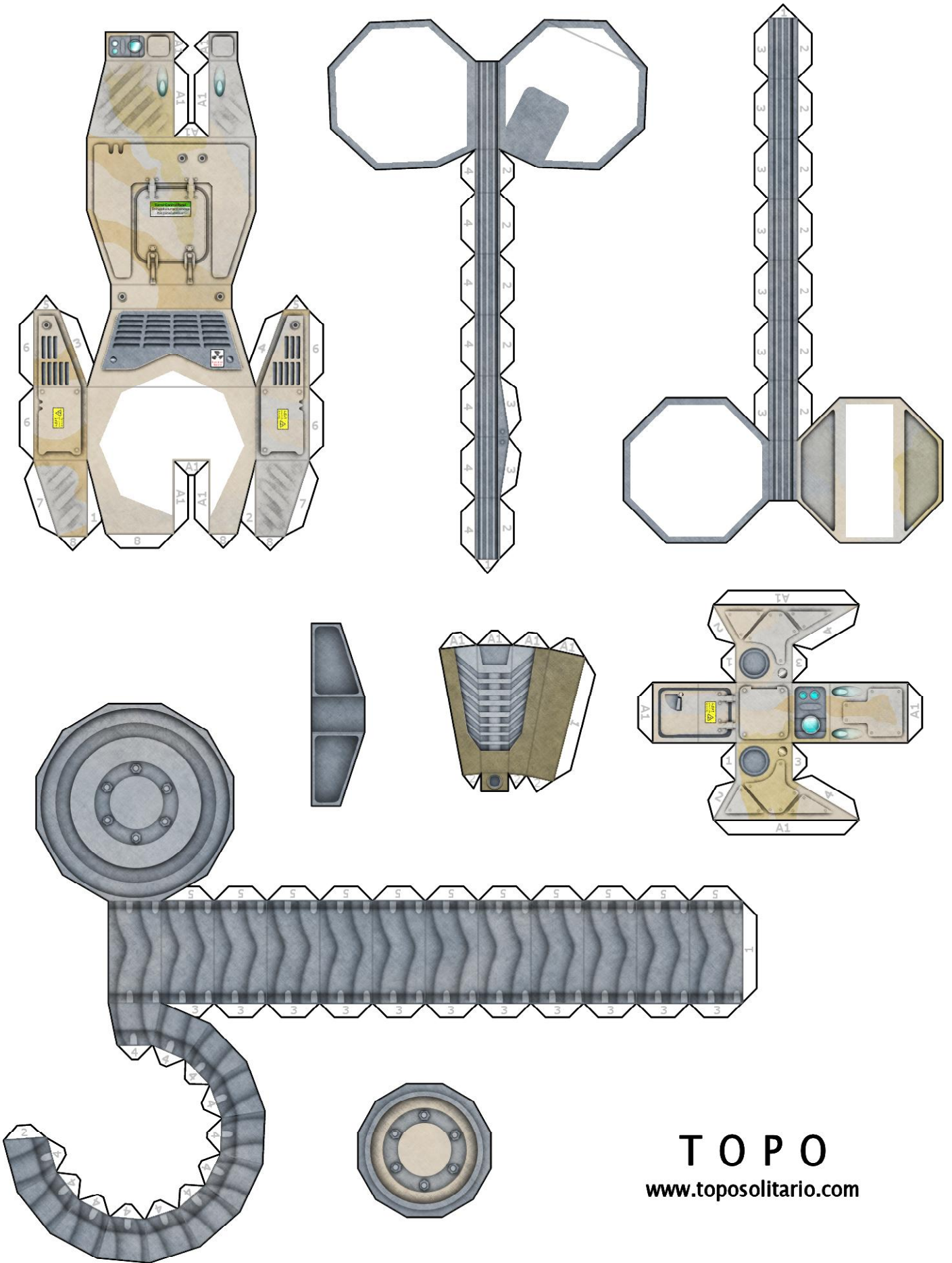

TOPO
www.toposolitario.com

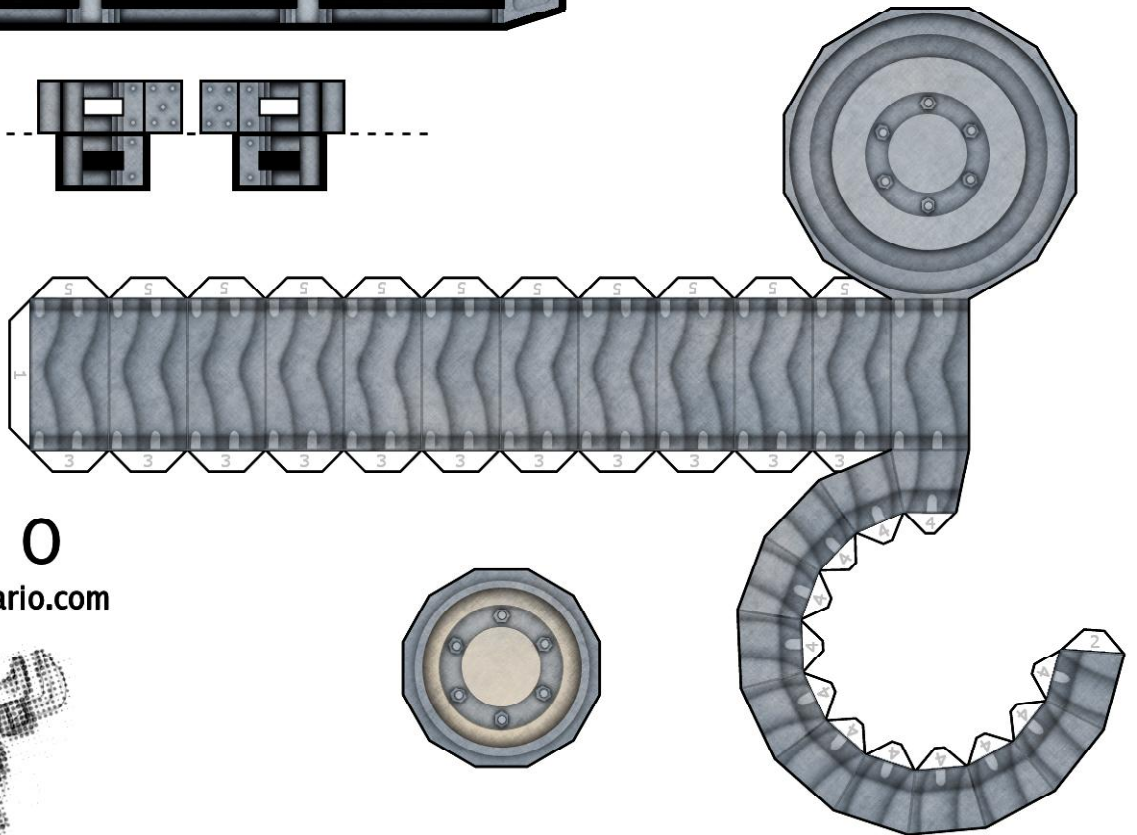
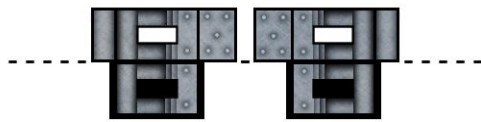
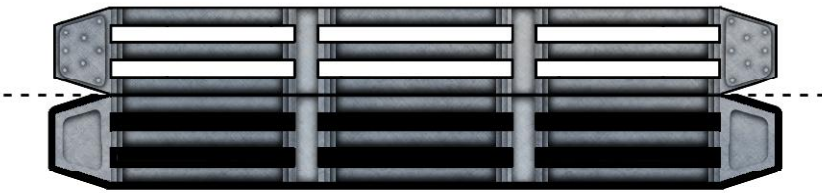
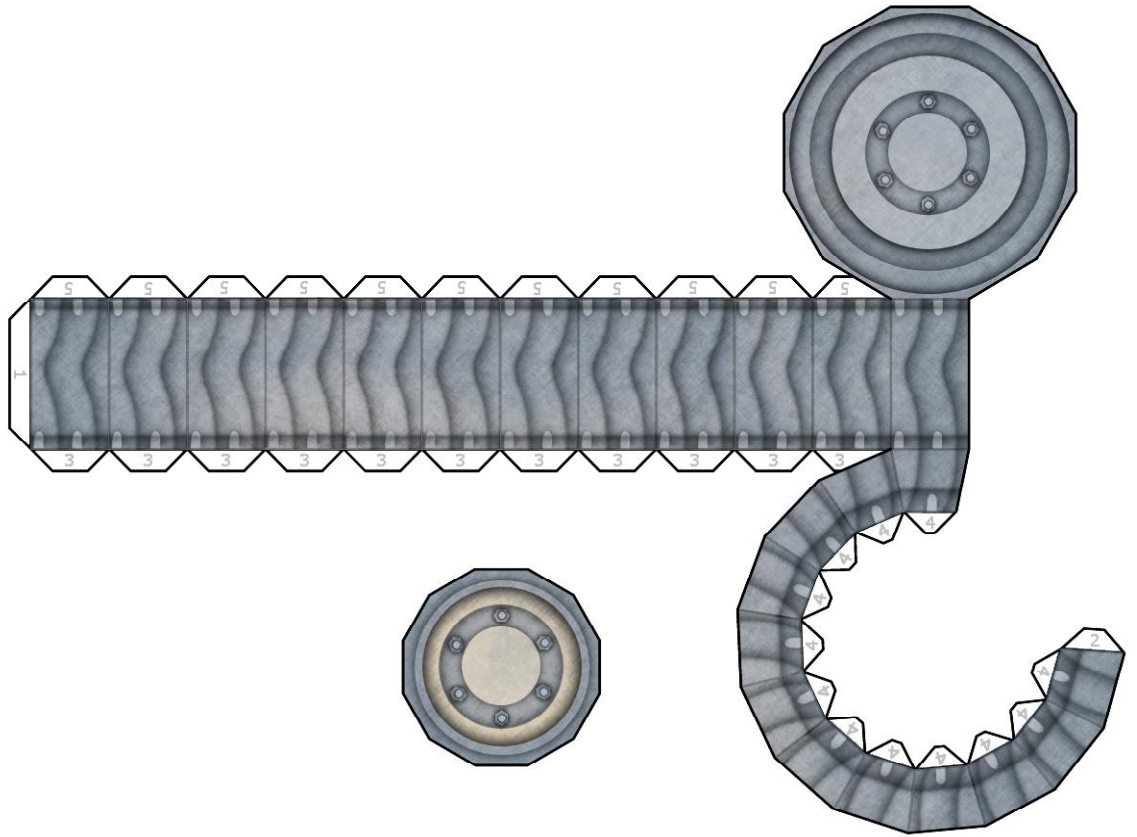

TOPO
www.toposolitario.com

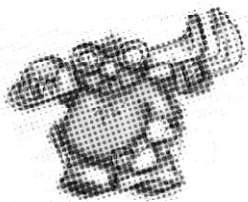

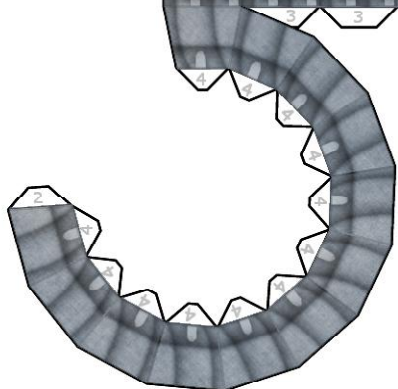
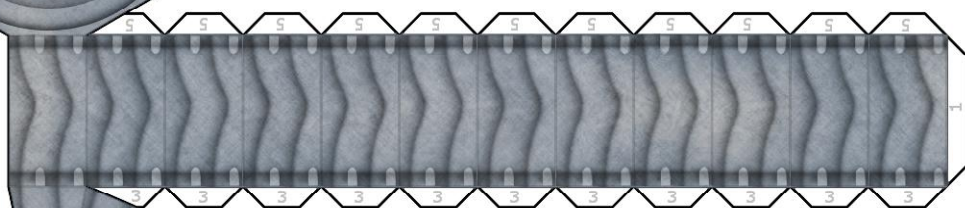
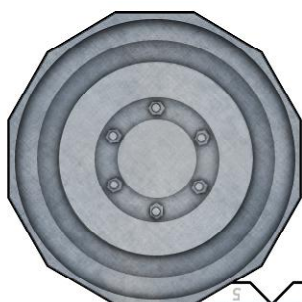
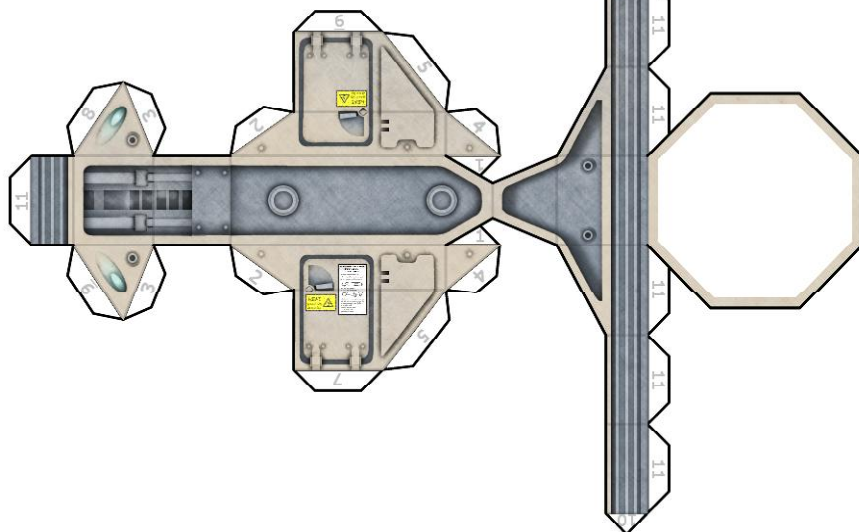
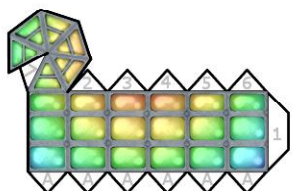
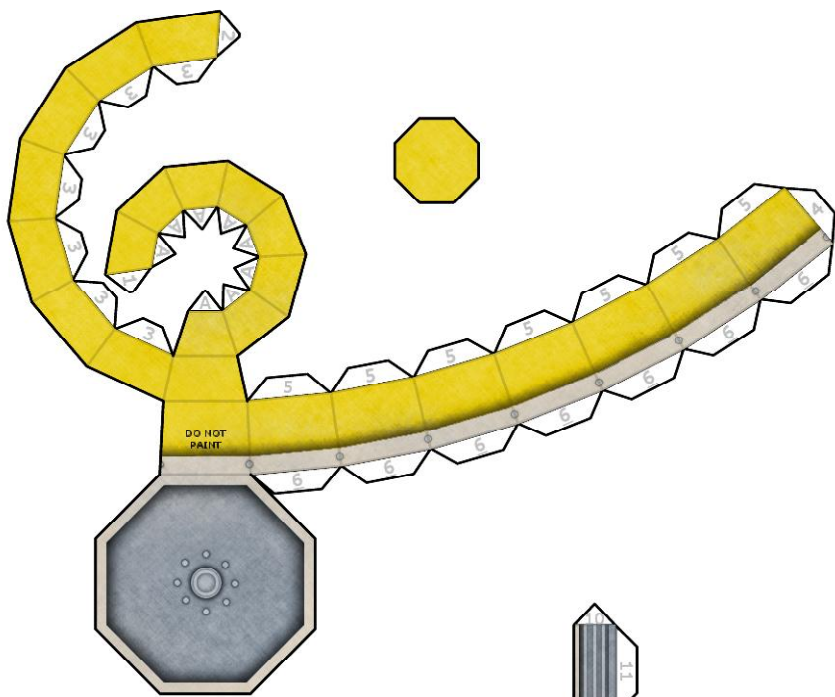
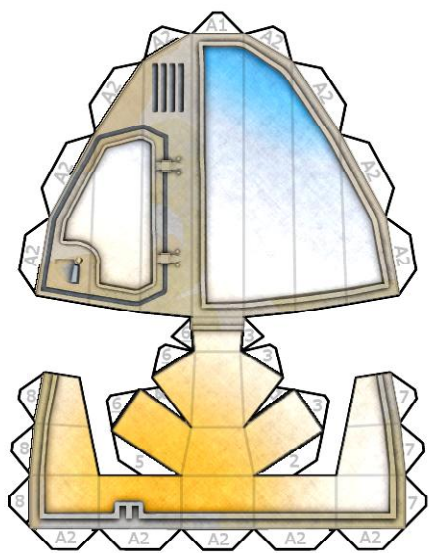

TOPO
www.toposolitario.com



TopoSolitario.com fue creada hace ya casi **6 largos años**, un proyecto que lejos de convertirse en un Blog o en una web de "estos son mis grupos favoritos y estos los *haikus que cago*" pretendía contener exclusivamente **CONTENIDO** (valga la redundancia), por ello siempre he intentado incluir cosas de utilidad, fotos, artículos, tutoriales... aunque admito que últimamente lo que mas me atrae son definitivamente los tutoriales y recortables que podéis encontrar en la sección WORKSHOP. Frecuentemente, sobre todo en el mundillo de los **recortables**, lo que encuentras en internet **o bien no llega al mínimo de calidad o bien tiene un precio que parte de los 5 dólares en adelante...** sin embargo desde un principio (y no sin críticas) **decidí ofrecer todo cuanto hiciera GRATIS.**

Después de esta parrafada solo puedo decirte que este no es mi trabajo sino mi *hobby* (uno de tantos) **y que aunque lo que mas ilusión me hace es ver cómo en los lugares mas recónditos aparecen enlaces a mis tutoriales o mis recortables en fotos de todas partes del mundo, también puedes demostrarme tu apoyo y reconocimiento con un pequeño donativo...**

Te garantizo que dicho donativo (a parte de pagar los paupérrimos gastos de la página) se invertirá en alimentar al *artista* con el combustible necesario para seguir con estos trabajos, si amigo, cerveza y vodka y pipas y pizzas... todo lo que sea necesario para *sobornar a la musa* y seguir poniendo en tu pantalla todo cuanto necesites.

Además cada *moneda de oro* que aportes me da un *punto de experiencia*, y eso hará que pronto suba de nivel y mejore aún mas en lo que hago :p



TopoSolitario.com was created almost **6 (long) years ago** as a project far from the blogosphere or the "*these are my favourite musicians and these are my crappy haikus*" kind of site; in fact I always tried to bring only **USEFULL CONTENT**. That's why I always tried to upload only tutorials, photos and the paper models that you can find in the WORKSHOP section.

Sometimes the stuff you find on internet, especially with **paper models**, has some drawbacks, for example **the quality is not enough, or you have to pay many more than 5 bucks for it...** My intention from the very beginning was to **give all that content for FREE.**

After all these words, all I can say is that this isn't my job but my hobby (one of many), **what really makes me happy is to find in the darkest corners of the earth links to my tutorials or my paper models in photos all around the world, but you can show me your support and how much you liked my FREE work with a little donation :)**

I guarantee that such donation (apart from paying the hosting and domain) will be spent in feeding the *artist* with the needed fuel to keep him working, yes my friend, beer and vodka and pizzas and burritos... all the elements needed to *bribe the muse* and keep giving you anything you need. And remember that every *gold coin* brings me another *Xperience Point*, so soon I'll go up a level and get much better in every skill I have :p

Mantén **WWW.TOPOSOLITARIO.COM** en funcionamiento

Colabora
Participa Apoya



Collaborate Support
Participate

<http://www.toposolitario.com/principal/donativos.html>